

Data Sheet



Article number: 20884473

Description: E+G Control handwheel
GN 736-62-B10-A

Measures

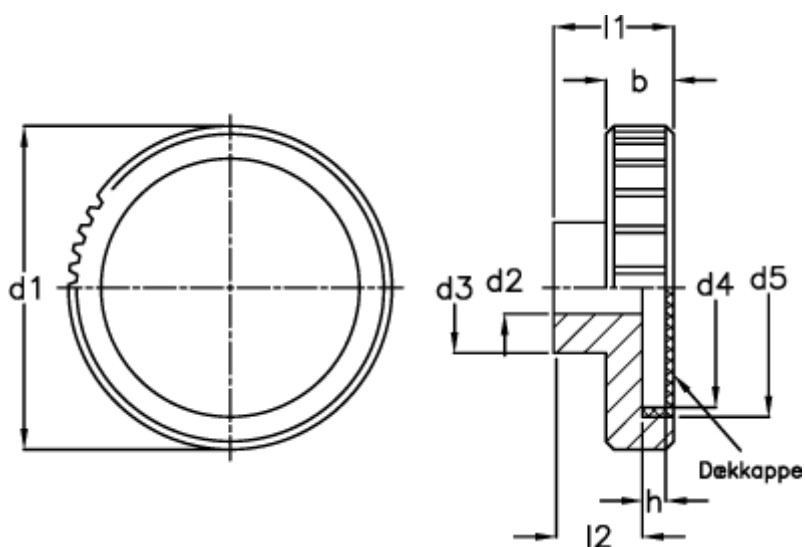

b -0.5	= 13	l1 = 23
d1	= 62	l2 = 17
d2 H8 without slot	= B 10	
d2 H8 with slot	= K 10	
d3	= 25	
d4	= 47	
d5	= 49.5	
h	= 3.8	